



Technical Data Sheet

ODS-AGM40E

(PC1100)

Battery Type

- With M6 SS studs
- Absorbed Glass Mat (AGM) with Thin Plate Pure Lead (TPPL)
- Advanced dual purpose battery for engine start and deep cycle use

Power and Performance

Voltage	12V
Pulse (5 second) Hot Cranking Amps (PHCA)	1100A
Cold Cranking Amps (CCA)	500A
HCA	800A
MCA	650A
20Hr Nominal Capacity (Ah)	45Ah
10Hr Nominal Capacity (Ah)	43Ah
Reserve Capacity Minutes	87 mins
Terminal	M6 Stud
Torque Spec in-lbs (Nm max)	35 (3.9)
Internal Resistance (mΩ)	5.1 mΩ
Short Circuit (A)	2450A

Drawings & Terminal Position

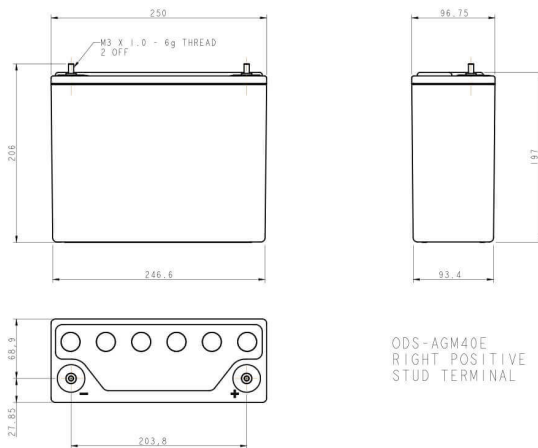

Handling and Storage

- Can be mounted or stored in any orientation except inverted
- 2-years storage life at 68°F (20°C) without needing to charge. Recharge when the OCV is <12.6V (50% SOC).
- Classified as non-spillable and approved as non-hazardous cargo for ground, sea and air transportation in accordance with the requirements of IMDG (International Maritime code for Dangerous Goods) and ICAO (International Civil Aviation Organisation)

Charging and Self-Discharge

Type of charging curve	IUU
Charger voltage at 68°F (20°C)	14.4V to 14.8V
Self-discharge per month at 68°F (20°C)	1.25%
Self-discharge per month at 104°F (40°C)	5%
80% depth of discharge cycles	400

Dimensions and Weight

Length	9.8 in / 249 mm
Width	3.8 in / 97 mm
Height (terminals included)	8.1 in / 206 mm
Height (container)	7.7 in / 196 mm
Weight	27.5 lbs / 12.5 kg

Temperature

Operating temperature range	-40°F / -40°C to 113°F / +45°C
Optimum storage temperature	68°F / +20°C

Accreditations

The management systems governing the manufacture of this product are ISO 9001 and ISO 14001 certified.

*Cold Start Performance S.A.E J537 Apr 2016



EnerSys World Headquarters
2366 Bernville Road
Reading, PA 19605, USA
Tel: +1-800-964-2837

EnerSys EMEA
EH Europe GmbH
Baarerstrasse 18
6300 Zug, Switzerland

EnerSys Asia
152 Beach Road
#11-08 Gateway East
Building
Singapore 189721
Tel: +65 6416 4800

Want more info?
Scan code to access
the ODYSSEY® Battery
Literature Library

